

Owner's Purchase Record

Model _____

Date of Purchase _____

Dealer Purchased From: _____

Serial #: _____

Copyright 2000, The Brunton Company
A subsidiary of Silva Production, AB

Printed in U.S.A.
form 51-600 rev 0011



**POCKET TRANSIT
INSTRUCTION MANUAL**

1 – IMPORTANT INFORMATION	Page(s): 1
2 – ORIENTATION	2
3 – MAGNETIC DECLINATION	4
4 – AZIMUTH MEASUREMENT	6
5 – VERTICAL & PERCENT GRADE MEASUREMENT	9
6 – COMPASS USE WITH A TOPOGRAPHIC MAP	12
7 – ADDITIONAL MEASUREMENT	13
8 – PROSPECTING	14
9 – REFERENCE MATERIAL	20
10 – SPECIFICATIONS	21
11 – SERVICE	22

1 -- Important Information

Congratulations on your purchase of the finest pocket transit instrument in the world. The Brunton Pocket Transit is not just a compass. It combines a surveyor's compass, prismatic compass, clinometer, hand level and a plumb into a single instrument. Use the Brunton Pocket Transit to measure azimuth (compass bearing), vertical angles, inclination of objects, percent grade, slopes, height of objects and for leveling.

Even though all Brunton Pocket Transits are made to be rugged, durable and withstand the rigor associated with outdoor use, care must be taken to assure long-life of your instrument. Avoid impacts, dropping, extreme temperatures, store in its case and the Brunton Pocket Transit will perform.

1.1 Opening The Pocket Transit

Rotate the pocket transit until the flat cover faces up, and the small window is positioned away from you. Unlatch the cover from the base. (Fig 1)

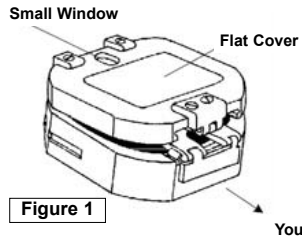

Figure 1

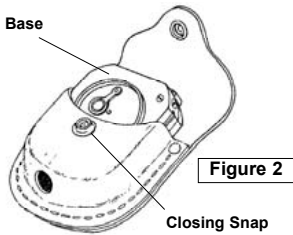

Figure 2

1.2 Protecting The Mirror

While in storage, Brunton recommends placing the pocket transit in the case, with the base against the closing snap. (Fig 2)

1.3 Direct Reading

Why are EAST & WEST switched?

Because the pocket transit is a **direct reading** compass. Read azimuth **directly** where the needle points on the graduated circle.

With the **large** sight toward the object, read azimuth directly where the **north** end of the nee-

dle points (white tip - 2001, 2061, 5005LM and 5006LM models, or "N" tip - 5007, 5008 and 8700 Com-Pro models). (Fig 3)

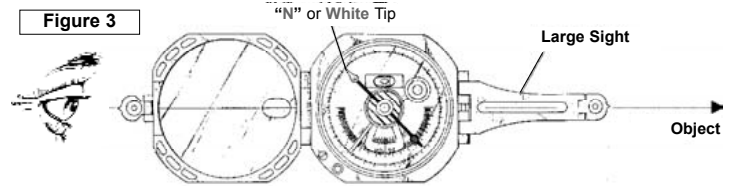

Figure 3

With the **small** sight toward the object, read azimuth directly where the **south** end of the needle points (**black** tip - 2001, 2061, 5005LM and 5006LM, or "**S**" tip - 5007, 5008 and 8700 Com-Pro models). (Fig 4)

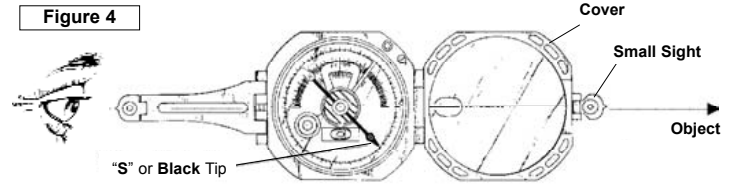

Figure 4

Detailed explanation of sighting an azimuth is in section 4.

2 -- Orientation

Orientation provides a description of important pocket transit parts. A detailed description of its operation is provided throughout the manual.

2.1 Needle (Fig 5)

The needle is induction damped, which allows the needle to seek magnetic north and come to a complete rest in a minimum amount of time, without accuracy degradation.

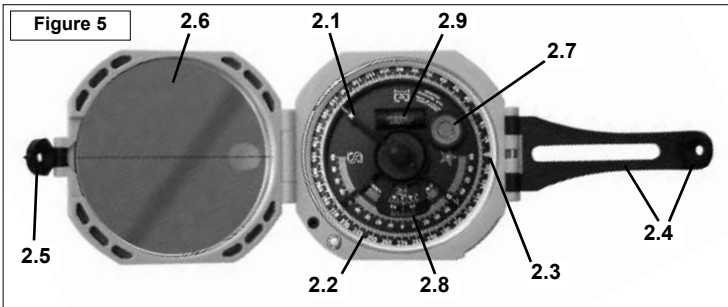

2.2 Graduated Circle (Fig 5)

In combination with the needle, the 1° graduated circle allows accurate 1/2° azimuth readings on both the Degree (0° through 360°) and Quadrant (0° through 90°) graduated circles.

2.3 Zero Pin (Fig 5)

The zero pin is the pointer used for magnetic declination adjustment. If no adjustment is necessary, the pin should point at 0°.

2.4 Large Sight w/ Peep Sight (Fig 5)

The large sight and the attached peep sight are used for precise azimuth measurement.

2.5 Small Sight (Fig 5)

Attached to the cover, the small sight is used for precise bearing and inclination sighting.

2.6 Mirror (Fig 5)

Located on the inside of the cover, the mirror and mirror center line are used for accurate azimuth measurements, when using the transit as a prismatic compass.

2.7 Round Level (Fig 5)

Use the round level to level the pocket transit for azimuth measurement.

2.8 Vernier (Fig 5)

The adjustable vernier is used in inclination measurements.

2.9 Long Level (Fig 5)

The long level for inclination measurement. Adjust the long level using the vernier adjustment - 2.11.

2.10 Circle Adjusting Screw (Fig 6)

With a screw driver, rotate the graduated circle by turning the circle adjusting screw.

2.11 Vernier Adjustment (Fig 6)

Use the vernier adjustment to adjust the vernier and long level for inclination measurements.

2.12 Ball & Socket Tripod Mount (Fig 6)

The slots on both sides of the body are for mounting to an optional Brunton tripod.

2.13 Alidade Mount -- Com-Pro Models Only (Fig 6)

The circular extension with slots, located on the bottom of the body, is for the attachment of an optional Brunton alidade (protractor). Only the Com-Pro models have this feature.

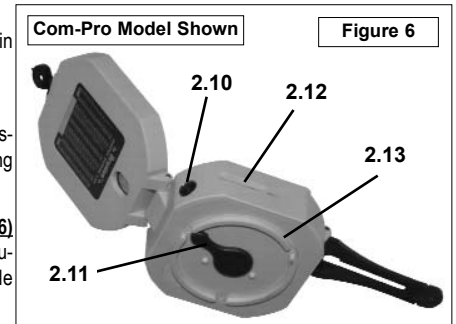

3 -- Magnetic Declination

The Earth is completely surrounded by a magnetic field, and an unobstructed magnetized object will orient itself with the earth's magnetic north and south poles. Magnetic declination (variation) is the difference between true geographic north (north pole) and magnetic north (in northern Canada), with respect to your position. It is important to note magnetic declination at your position, because magnetic declination varies and fluctuate slowly at different rates, around the world. (Fig 7, p.5)

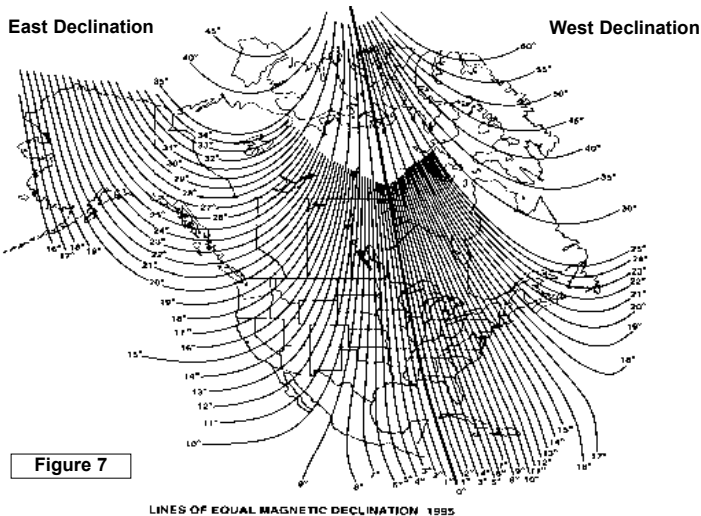

Figure 7

LINES OF EQUAL MAGNETIC DECLINATION 1995

The isogonic chart shows North America, only. Use an isogonic chart, or current United States Geological Survey (USGS), Bureau of Land Management (BLM), or another map to determine magnetic declination at your position. Declination can be east, west or even 0°, from your current position. At 0° declination, true north and magnetic north are aligned.

Example: If magnetic declination at your position is 15° east, then magnetic north is 15° east of true geographic north. Figure 8 displays true geographic north and magnetic north, as indicated in the legends of USGS and BLM maps.

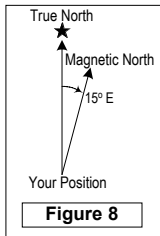
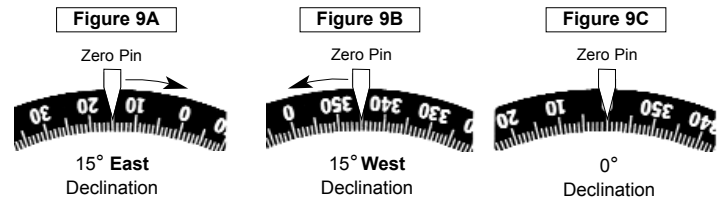

Figure 8

Most maps use true north as a reference. When adjustment for magnetic declination is complete, azimuth readings will be with respect to true north, same as the map.

To adjust for magnetic declination, rotate the graduated circle by turning the circle adjusting screw. Begin with the zero pin at 0°. For **East** declination, rotate graduated circle **clockwise** from the zero pin. (Fig 9A) For **West** declination, rotate graduated circle **counterclockwise**. (Fig 9B) If magnetic declination is 0°, no adjustment is necessary. (Fig 9C)



4 -- Azimuth Measurement

Azimuth is a term used for direction. Azimuth is normally measured clockwise, in degrees with true north being 0°. Bearing is a term often used when measuring with a quadrant type instrument. From this point forward, description of pocket transit use will involve the 0° through 360° graduated circle, and assume the pocket transit is adjusted for magnetic declination. Example of Azimuth: If a mountain is directly east of your position, the azimuth from your position to the mountain is 90°. If the mountain is directly south of your position, it would be at 180°.

Caution: The magnetic needle is highly sensitive. When sighting an azimuth, keep the pocket transit away from magnetic materials, such as watches, belt buckles, rings, knives, cigarette lighters, ... etc.

4.1 Azimuth Using a Tripod or Unipod

When the greatest accuracy is required, mount the pocket transit on a Brunton non-magnetic

tripod using Brunton's Ball and Socket head. See section 11 for ordering information.

1. Adjust pocket transit for magnetic declination.
 - See section 4, Magnetic Declination, for help.
2. Mount transit to the ball and socket head.
3. Open both the cover and large sight, until they extend parallel to the body. (Fig 10)
4. Flip small sight and peep sight up. (Fig 10)
5. Rotate transit until large sight points at object.
6. Level the transit by centering bubble in round level.
7. Sight azimuth by aligning peep sights with object. (Fig 11)

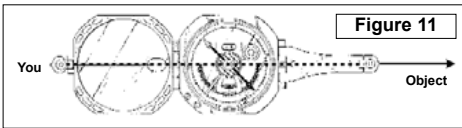

Figure 11

4.2 Azimuth Measurement Waist-Level

This method is often used when object is above or below the observer.

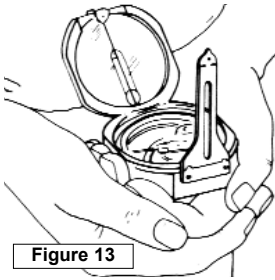

Figure 13

4.2.a Using "N" End of Needle

This method is often used when the object lies as much as 45° above, or 15° below the observer.

1. Hold transit waist high and in your left hand.
2. Open cover toward your body to approximately 45°.
3. Open large sight, until perpendicular to the body. (Fig 13)

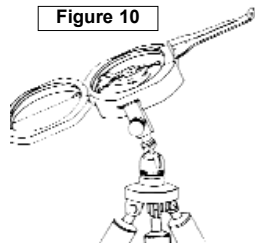

Figure 10

8. Read azimuth where the "N" end of the needle points at graduated circle -- 60°. (Fig 12)

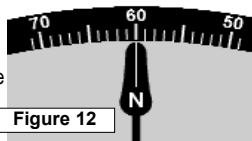

Figure 12

4. Press left forearm against your waist and steady with right hand.
5. Level compass using round bubble level.
6. Look into the mirror, and bisect the large sight and the object with mirror center line. (Fig 14)
 - Check that bubble is centered in round bubble level.
7. Read azimuth where the "N" end of needle points at the graduated circle.

If object is more than 45° above you, open mirror further toward your body, and adjust large sight so that it leans over the bottom case. Then repeat the procedures described in 4.2.a.

4.2.b Using "S" End of Needle

Use this method when object is more than 15° below the observer.

1. Hold transit waist high and in your left hand.
2. Open cover away from your body to approximately 45° from level. (Fig 15)
3. Open large sight, until it leans over the body at approximately 45°. (Fig 15)
4. Press left forearm against your waist and steady with right hand.
5. Level compass using round bubble level.
6. Look just over the large sight, and at the object through window opening on mirror. (Fig 15)
 - Adjust mirror and large sight so the image of the large peep sight are bisected by the mirror center line.
 - Check that bubble is centered in round bubble level.
7. Read azimuth where the "S" end of needle points at the graduated circle. (Fig 16)

4.3 Using as a Prismatic Compass

Occasionally, objects may interfere with sighting using

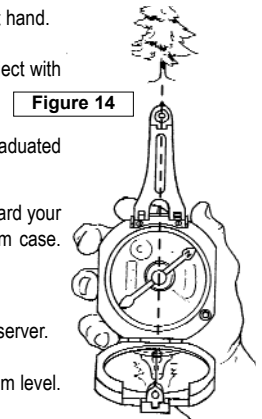

Figure 14

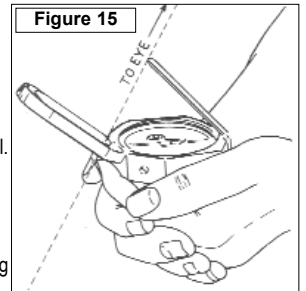

Figure 15

methods previously mentioned, or user may encounter circumstances which require the transit be held at eye-level to sight an object. If this is the case, follow the procedures below.

1. Open cover away from your body to approximately 45°, and open small sight. (Fig 17)
2. Lift large sight until perpendicular to the body, or leans slightly away from the base. (Fig 17)
3. Hold instrument at eye-level, with large sight toward you.
4. Align large sight and small sight on top of the cover with object.
 - OR - Sight object through the lower portion of large sight and the window in the mirror.
5. Level round bubble level in the reflection of the mirror.
6. Read azimuth in the reflection of the mirror, where the "S" end of needle points at the graduated circle.

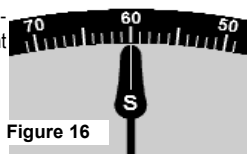

Figure 16

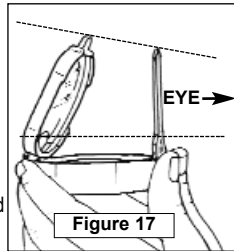

Figure 17

5 -- Vertical & Percent Grade Measurement

The Brunton Pocket Transit is capable of measuring vertical angles with accuracy better than 1°, with readings to 10 minutes. It can also display percent grade, without any calculation.

The bottom scale is incremented from 0° to 90° and is used for vertical inclination. The scale on the vernier is also used for vertical (inclination) measurement, but it is incremented from 0 to 60 minutes. (Fig 18) Closer to the center, the second scale increments from 0% to 100%. This scale is the percent grade scale.

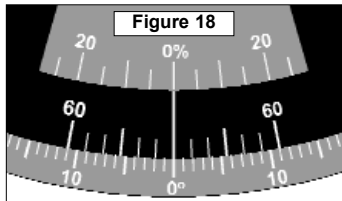

Figure 18

5.1 Inclination and Percent Grade Using Tripod

9

Use a tripod, or unipod for greatest inclination accuracy possible.

1. With pocket transit attached to the tripod using the ball and socket mount, tilt the head 90°. (Fig 19).
 - Transit should be on its side.
2. Lock into position using the clamp screw.
3. Align sights with object behind transit. (Fig 19)
4. Adjust vernier until bubble is centered in long level.
5. Read inclination at vernier's center line from the degree scale -- 26°. (Fig 20)

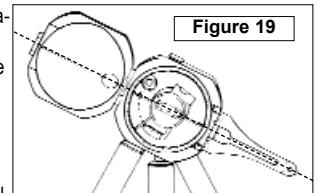

Figure 19

5.1.a -- inclination to the nearest 30 minutes

When 30 minute readable accuracy is required, use the vernier scale (0--60 min. with 10 min. increments).

1. Read inclination at vernier's center line -- 26° + ??.
2. Find minutes by determining whether the 30 or 60 min. line is closest to a degree marking.
 - A Loupe or magnifier may be required.

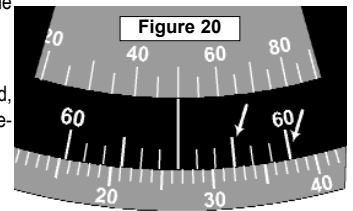

Figure 20

Since the 30 minute line is closest, the total angle is 26° + 30' (26° 30' or 26.50°)

5.1.b -- percent grade

When percent grade is required use the percent scale directly above the vernier.

1. Read nearest percent grade at the vernier's center line -- 50%. (Fig 20)

For greater accuracy, *calculate* the percent grade using the following equation.

$$\text{Percent Grade} = [\tan(\theta) \times 100]$$

Measure the angle of inclination, $\theta = 26.5^\circ$. Then calculate the tangent of 26.5° using a calculator. Finally, move the decimal two places to the right (multiply by 100).

10

Example: $\tan(26.5^\circ) = .499 = 49.9\%$ Grade

5.2 Inclination Using Prismatic Compass

The pocket transit can also measure angles of inclination without a tripod.

1. Open small sight and large sight as far as possible.
2. Flip peep sight up on large sight, .
3. Position Cover to approximately 45° .
4. With large sight pointing toward you, position transit at eye-level with cover open to the left. (Fig 21)
5. Sight object behind transit, aligning small sight, window and peep sight with object.
6. In mirror, adjust vernier until bubble in long level is centered.
5. Read inclination or percent grade at vernier's center line.

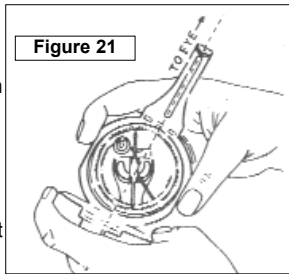

5.2.a Height Measurement Using Vertical Angles

1. Sight inclination, as described in section 5.2.
2. Apply height calculation as shown in Figure 22A or 22B.

Note: Do not calculate tangent of an angle by adding tangents of two smaller angles.

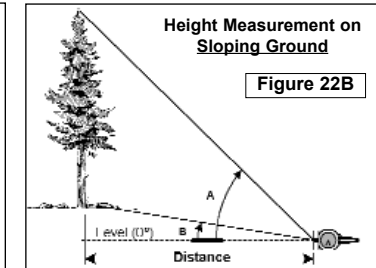
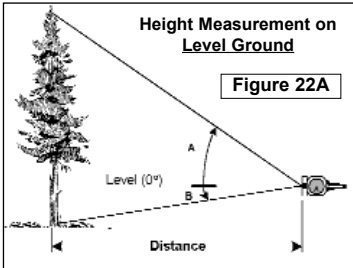

11

Level Ground

$$\text{Height} = (\tan A + \tan B) \times \text{Distance}$$

Example: $A = 36^\circ$, $B = 10^\circ$ & Distance = 50 ft.

$$\text{Height} = (\tan(36^\circ) + \tan(10^\circ)) \times 50'$$

$$\text{Height} = (.727 + .176) \times 50$$

$$\text{Height} = (.903) \times 50$$

$$\text{Height} = 45.15 \text{ ft.} = 45'$$

Sloping Ground

$$\text{Height} = (\tan A - \tan B) \times \text{Distance}$$

Example: $A = 38^\circ$, $B = 10^\circ$ & Distance = 75 ft.

$$\text{Height} = (\tan(38^\circ) - \tan(10^\circ)) \times 75'$$

$$\text{Height} = (.781 - .176) \times 75$$

$$\text{Height} = (.605) \times 75$$

$$\text{Height} = 45.38 \text{ ft.} = 45'$$

Example: $\tan(60^\circ) \neq \tan(30^\circ) + \tan(30^\circ)$ Find $\tan(60^\circ)$ from a table, use a calculator, or step back until angle of inclination is less than 45° .

5.2.b Height Measurements Using % Grade

Level Ground

Figure 23A

$$\text{Height} = (A + B) \times \text{Distance}$$

Example: $A = 72.7\%$, $B = 17.6\%$ & Distance = 50 ft.

$$\text{Height} = (72.7\% + 17.6\%) \times 50'$$

$$\text{Height} = (.903) \times 50'$$

$$\text{Height} = 45.15 \text{ ft.} = 45'$$

Sloping Ground

Figure 23B

$$\text{Height} = (A - B) \times \text{Distance}$$

Example: $A = 78.1\%$, $B = 17.6\%$ & Distance = 75 ft.

$$\text{Height} = (78.1\% - 17.6\%) \times 75'$$

$$\text{Height} = (.605) \times 75'$$

$$\text{Height} = 45.38 \text{ ft.} = 45'$$

6 -- Compass Use with a Topographic Map

1. Sight % Grade using level or sloping ground, same as in Figures 22A & B, p. 11.
2. Apply height calculation, as show in figures 23A & 24B.

A United States Geological Survey (USGS) topographic map is a 2-dimensional drawing of 3-dimensional terrain. Hills, valleys, ridges, cliffs and other terrain are represented through a series of contour lines. Each line represents constant elevation in feet or meters above sea level. Find the contour interval in the legend of the topo-map. With practice, you'll begin to recognize contours, labeling and identify passable routes.

6.1 Map Azimuth

1. On the topo-map, place a "point" at a starting position and an "X" at a destination.

12

2. Draw a line connecting both marks.
3. At the starting position, draw a true north line. (Fig 24, p.13)
 - Use true north indicator in the legend, or the edge of printed topo-map for reference.
4. Using the Alidade (Com-Pro models only), or a protractor, find the angle from the starting position to the destination, "X".

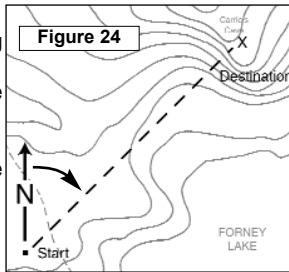

Remember, the true north line is 0°.

From the start position in the field, sight azimuth determined from the map, and you will be facing the destination. See section, [4 - Azimuth Measurement](#), for help.

6.2 Triangulation

Triangulation is a method used to find your approximate position, using a compass and a map. Make sure the pocket transit is adjusted for magnetic declination.

1. Identify three landmarks in the field, that you can identify on a topo-map.
2. Sight an azimuth to each land mark and document.
3. Draw an azimuth line on the map for each azimuth.

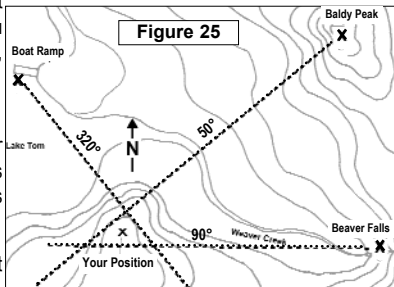

7 -- Additional Measurement

4. Your position is within the small triangle, or position formed by the intersection of the three lines. (Fig 25)

7.1 Level

The transit can be used as a level, to run level lines, or to determine points of elevation which is the same as the users eyes.

1. Adjust Vernier to 0° inclination, using the lever on the back of the body.
2. Place transit on its side, on an object, or use the tripod. (Fig 26)
3. Tilt instrument until the bubble is centered in the long level.

7.2 Plumb Bob

1. Suspend the transit in an open position from the large peep sight. (Fig 26)
2. Use the small sight as the pointer.

7.3 Inclination

8 -- Prospecting

1. Place instrument on its side on and object. (Fig 26)
2. Move lever on the back of the body until the bubble in the Long Level is centered.
3. Read inclination in either degrees or % grade.

If you were to discover gold, silver, or another valuable mineral deposit, you would want to "stake a claim". It would be necessary to construct a map of your claim, and tie (locate) your claim relative to some known position. Your Brunton Pocket Transit is ideally suited for this job, since it is essentially the same instrument used by geologists, mining engineers for prospecting and mapping around the world, since 1896.

8.1 Laws Governing Prospecting

In 1872 the General Mining Laws were enacted, and since then more laws have been passed governing the western United States. **Currently, state laws vary widely and the federal laws concerning mining claims are quite vague. A discussion of the law is beyond the**

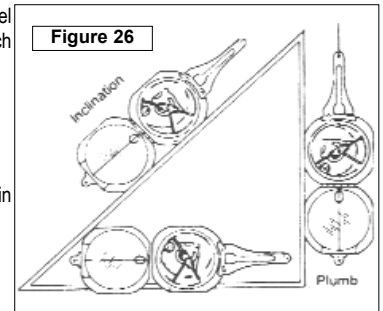

scope of this manual and it is strongly advised that you contact your state and federal agencies for information concerning "staking a claim".

**Following, is general information on mining claims for basic understanding.
RULES AND LAWS MAY HAVE CHANGED.**

1. **Lands Open to Mining Claims** - Lands available for mining claims can be determined by examining records from the Federal Land Office and the U.S. Bureau of Land Management (BLM), for your state. Generally, mining claims are limited to western states, where public land still exists. This includes public lands administered by the U.S. Forest Service, and U.S. BLM. It excludes national parks, monuments, state owned land and privately owned lands.
2. **Qualification** -- An individual must be a United States citizen, or one who has declared their intention to become a citizen. A corporation must be organized under the laws of the United States, or one of the fifty states. There are no restrictions as to age or residency.
3. **Federal Requirements** - The location must be distinctly marked on the ground so that its boundaries can be readily traced. All records of mining claims shall contain the name, or names of the locators, the date of the location and such a description of the claim or claims located by reference to some natural object or permanent monument as will identify the claim.
4. **State Requirements** - Each mining district may make regulations not in conflict with the laws of the United States, or with the laws of the state or territory in which the district is situated governing the location, manner of recording and amount of work necessary to hold position of a mining claim. This means the details of location are left to the states.
5. **Type of Claims** - There are four types of claims: lode claims, placer claims, mill sites, and tunnel sites. *Only lode claims are discussed here.*
6. **Lode Claims** - A lode is defined as a zone or belt of mineralized rock lying within boundaries clearly separating it from the neighboring rock. The dimensions of a lode claim are a maximum of 1,500 feet along the lode or vein, and no more than 300 feet to either side of the vein; end lines must be parallel.

Following, is an example of state regulations -- Nevada lode claim location requirements.

1. Erect a *discovery monument* at the point of discovery, and post thereon a *location notice* containing: (a) the name of the claim, (b) the name and mailing address of the locator, (c) the date of location, (d) the number of linear feet along the vein each way from the discovery monument, with the width claimed on either side of the vein, and (e) the general course of the vein. (NRS 517.010)
2. All monuments must consist of (a) a tree cut of 3 or more feet above the ground and blazed, (b) a rock pile 3 or more feet in height, or (c) a 4-inch diameter post at least 4 1/2 feet in length set 1 foot in the ground. (NRS 517.030)
3. Within 20 days of posting the location notice, mark the boundaries of the claim by placing monuments at the four corners and center of each side line. (NRS 517.030)
4. Within 90 days of posting the location notice, prepare two copies of a claim map (scale of 500 feet to the inch) showing the position of the claim monuments, the relationship of the claim monuments and the relationship of the claim group to a survey corner, or claim location marker. The marker must be a rock pile 4 feet in diameter and 4 feet high, or a steel post 3 inches in diameter and 5 feet high. The description must also include the section, township and range. The map need not be perfect, but "in accordance with the locator's abilities." (NRS.030) The maps must then be filed with the county recorder. (NRS 517.040 (2))
5. Within 90 days of posting the location notice, record duplicate location certificates with the county recorder containing the following information *(NRS 517.050):
 - a. The name of the lode or vein.
 - b. The name of the locator or locators, together with the post office address of such locator or locators
 - c. The date of the location.
 - d. The number of linear feet claimed in length along the course of the vein each way from the point of discovery with width of each side of the center of the vein, and the general course of the lode or vein as near as may be.
 - e. A statement that the location work consisted of making the maps as provided in (NRS 517.040).

- f. The location and description of each corner, with the markings thereon.
- 6. Only one location may be claimed on each location notice or location certificate (NRS 517.020, 517.050).
- 7. Penalty for late recording: "any record of the location of a lode mining claim which shall not contain all the requirements named in this section recorded on or after July 1, 1971, shall be void, and every location of a mining claim recorded on or after July 1, 1971, shall be absolutely void unless a certificate of location thereof substantially complying with the above requirements is recorded with the county recorder of the county in which the claim is located within 90 days after the date of location." (NRS 517.050 (2))

Other states commonly require some form of discovery work other than preparation of a map. This may consist of digging a shaft or drilling a specified footage of discovery holes. *Check the mining statutes of every state to determine its specific requirements.*

8.2 Surveyed Land

In locating your mining claims and constructing your claim location map, it will be helpful to understand how lands are divided up by the rectangular system of surveys. This system is the basis for the identification, administration and disposal of public lands.

Figure 27 illustrates how lands are divided by survey. Lines running north-south are called range lines. R22E stands for Range 22 East of the principal meridian. Lines running east-west are township lines. T22S stands for Township 22 South of the base line. On a topo-map, the range lines are shown at the top and bottom of the printed map. Township lines are shown on the

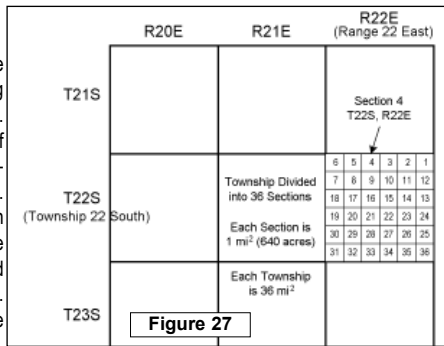

17

east-west margin of the map.

By specifying the township and range, a township area of land is located. The large squares in figure 27 are townships. For example, T22S, R22E specifies the township area with 36 sections, each numbered and 1 mi² (640 acres) apiece. This makes a township is 36 mi². A 1mi² section of land is located by calling out the section number, township and range -- Section 4, T22S, R22E.

A section is further divided into quarter sections by straight lines connecting quarter section corners or opposite boundaries. There are eight monuments on each section. One monument on each corner and one midway between corners on the section boundary lines (not shown).

If your claim is in a surveyed area of public land, it will be located within a section shown on a topo-map. To locate your claim, it is then necessary to tie, or locate your claim relative to a section corner monument. The corner monument may be a pipe with a brass cap fastened to the top. It may be a brass tablet. 3 1/4 by 3 1/2 inches, attached to a rock outcropping and set in concrete. The brass is marked with letters and figures that give the section, township and range. It is marked so that it must be read while standing on the south side of the monument. The south side of the monument is marked with the date of the monument. (Fig 28)

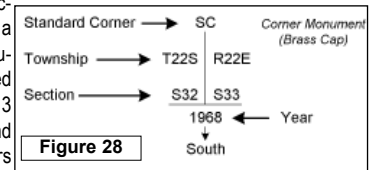

8.3 Sample Claim Location Map

Figure 29 on page 20, shows the location monument with claim extending 300 feet to each side of the vein center line and 1,500 feet long. The claim is tied or located to a section corner post by showing the bearing to the corner post, the number of feet to the post and the section, township and range.

The bearing is obtained with your Brunton Pocket Transit by selecting one of your claim corners as your tie point, and sighting from the tie point to the section corner post. The azimuth

18

to the South East corner of Section 32, T22S, R22E was found to be 110°. (Fig 29, p. 20). Note, the distance to the section corner must also be provided.

8.4 Location On Unsurveyed Land

Not all of the U.S. has been surveyed. As of 1970, about 500,000,000 acres were still unsurveyed. Most of the unsurveyed land is located in mountainous sections of the country. Since then, however, more has been surveyed. Check with the Federal Land office, or the U.S. Bureau of Land Management of your state.

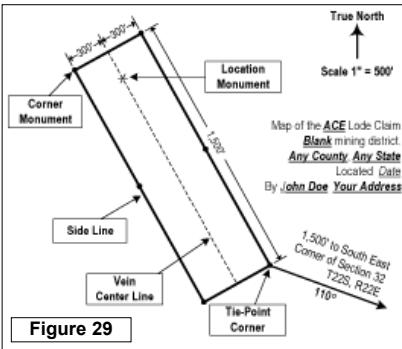

Figure 29

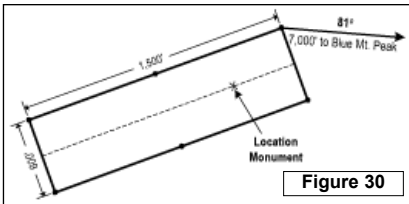

Figure 30

your claim in reference to some natural land mark. A natural land mark being a mountain top, intersection of a river and a stream, etc.

8.4.a Using Bearing & Distance

Figure 30 shows a claim tied to Blue

If your claim is located in one of the unsurveyed areas (no corner post to locate, or tie your claim), you must locate

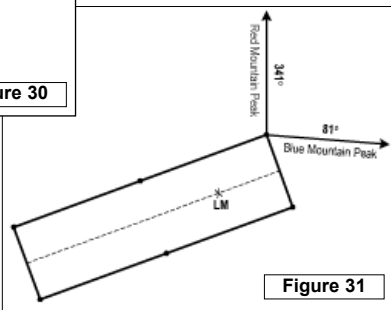

Figure 31

Mountain Peak by an azimuth of 81°, and a distance to Blue Mountain Peak of 7,000 feet from a corner monument.

8.4.b Using Two Bearings

The claim in figure 31 is tied to two azimuth readings from a corner monument. Using this method, distance is not required, since the intersection of both azimuth lines determine the location.

8.4.c Using Five Bearings

A more complete description of your claim can be determined by displaying the direction of the sides of your claim. The angles are found by standing on corner #1 and taking an azimuth to corner #2. Then standing on corner #2 and taking an azimuth to corner #3. Finally, from #3 to #4 and from #4 back to #1, thus completing the description.

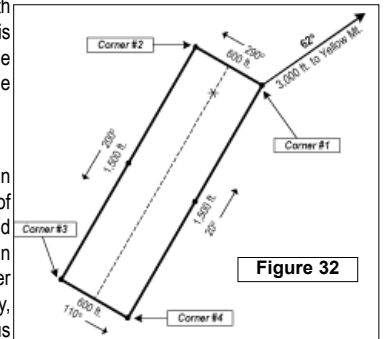
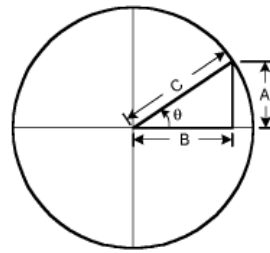

Figure 32

9 -- Reference Material



$SIN(\theta) = A/C$ $CSC(\theta) = C/A$
 $COS(\theta) = B/C$ $SEC(\theta) = C/B$
 $TAN(\theta) = A/B$ $COT(\theta) = B/A$

A = side opposite angle θ
 B = side adjacent to angle θ
 C is the hypotenuse
 $C^2 = A^2 + B^2$

Inches	Feet	mm	cm	Conversions	Conversions
1/8	0.0104	3.1750	.31750	1 inch = 2.54 centimeters	1 centimeter = 10 millimeters
1/4	0.0208	6.3500	.63500	1 foot = 12 inches	1 centimeter = 0.01 meters
3/8	0.0313	9.5250	.95250	1 foot = 0.305 meters	1 centimeter = 0.394 inches
1/2	0.0417	12.700	1.2700	1 yard = 3 feet	1 meter = 100 centimeters
5/8	0.0521	15.875	1.5875	1 yard = 0.914 meters	1 meter = 3.281 feet
3/4	0.0625	19.050	1.9050	1 chain = 66 feet	1 meter = 1.094 yards
7/8	0.0729	22.225	2.2225	1 mile = 5,280 feet	1 kilometer = 1,000 meters
1	0.0833	25.400	2.5400	1 mile = 80 chains	1 kilometer = 0.6214 miles
2	0.1667	50.800	5.0800	1 mile = 1.609 kilometers	1 hectare = 10,000 meters ²
3	0.2500	76.200	7.6200	1 acre = 43,500 feet ²	1 hectare = 2.471 acres
4	0.3333	101.60	10.160	1 acre = 0.4047 hectares	
5	0.4167	127.00	12.700		
6	0.5000	152.40	15.240		
12	1.0000	304.80	30.480		

10 -- Specifications

description of the claim shown in Figure 32, would read:

Beginning at Corner #1, the NE corner of the claim.

Thence 600 feet, 290° to Corner #2.

Thence 1,500 feet, 200° to Corner #3.

Thence 600 feet, 110° to Corner #4.

Thence 1,500 feet, 10° to Corner #1.

Magnetism: Models - 2001 & 2061 (*Alnico II Bar Magnet*)
 Models - 5005LM & 5006LM (*Alnico V Bar Magnet*)
 Models - 5007, 5008 & 8700 Com-Pro (*NdFeB Magnet*)

Accuracy: Bearing -- +/- 1/2° accurate
 Inclination -- +/- 1° accurate (30 minute readable)

11 -- Service

Size (Closed): Width -- [2001, 2061, 5005LM & 5006LM models] - 2.79 in. (7.09 cm)
 Width -- [5007, 5008, 8700 models] - 2.76 in. (7.01 cm)
 Length -- [2001, 2061, 5005LM & 5006LM models] - 3.09 in. (7.84 cm)
 Length -- [5007, 5008, 8700 models] - 3.14 in. (7.97 cm)
 Height -- [2001, 2061, 5005LM & 5006LM models] - 1.31 in. (3.34 cm)
 Height -- [5007, 5008, 8700 models] - 1.33 in. (3.38 cm)
 Weight -- [2001, 2061 models] - 6.8 oz (19.3 g)
 Weight -- [5005LM & 5006LM models] - 7.1 oz (20.1 g)
 Weight -- [5007, 5008, 8700 models] - 5.7 oz (16.2 g)

Engraving - A Brunton Pocket Transit with a cast aluminum body can be personalized with engraving (up to 18 characters, including spaces). Com-Pro models have a decal which can have up to 6 lines of text (approximately 20 characters per each line, including spaces). Call Brunton at (307) 856-6559 for details.

Balancing - Brunton Pocket Transits can be balanced for use in a specific part of the world. Special balancing is required for use in the southern hemisphere. Call Brunton for details.

Repair - Brunton's repair department is capable of handling repairs, or conversions of any genuine BRUNTON Pocket Transit. Periodic maintenance and calibration is highly recommended and will prolong the life of your pocket transit. Call Brunton for details.

Accessories



**3051
Jacob Staff
Thimble**
Attaches transit to steel tipped
wooden rod or Jacob's staff. Ball
and socket head is also required.



**3040
Ball & Socket**
Attaches transit to
tripod. Swivels 90°
in any direction for
reading verticle angle
measurements and
rotates 360° for
horizontal
measurements.

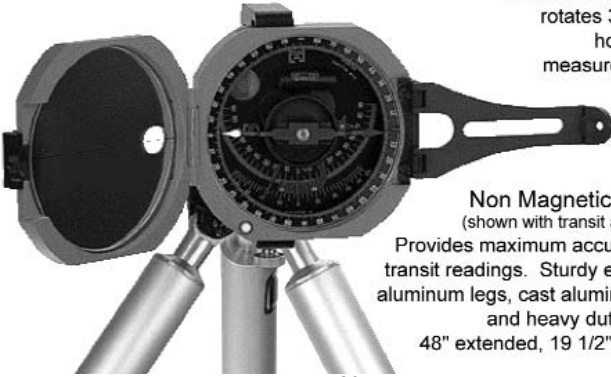

**3051
Non Magnetic Tripod**
(shown with transit attached)
Provides maximum accuracy for
transit readings. Sturdy extruded
aluminum legs, cast aluminum top
and heavy duty joints.
48" extended, 19 1/2" closed.

23

Brunton Professional Instruments

Pocket Transits

MODEL	NEEDLE/GRADUATIONS
2001	Conventional, QUADS - 4x90°
2061	Conventional, 0-360°
5005LM	International, QUADS - 4x90°
5006LM	International, 0-360°



5007 COM-PRO, International, QUADS - 4x90°
5008 COM-PRO, International, 0-360°



SM 360LA

SUM 360LA

Sighting Compasses
Gives bearing, height, distance
or inclination to objects.
Sturdy anodized aluminum
body. Available with nylon
or leather case.

24

Other Brunton Products

8099 Eclipse™
Award winning,
revolutionary
compass.



4006W 7x42 Eterna™
Superior quality -
lifetime
warranty.



**15TDCL
Elite™**
Traditional,
dependable
quality.

Multi Navigator™
MNS™ system -
more than
a GPS!



Sherpa™
Hand held
weather
data center.



Brunton manufactures MNS™ (more than a GPS) systems, high quality optics, hand held data measuring devices and a complete line of recreational compasses. Refer to back cover for contact information on products, service or for full line catalogs.

25

Warranty Registration

Detach and return to: Brunton, 620 East Monroe Avenue, Riverton, WY 82501-4997

Name: _____

Address: _____

City: _____ State: _____ Zip: _____

Phone: _____

Model #: _____ Serial #: _____

Date Purchased: _____ Store: _____

City: _____ State: _____ Zip: _____

Amount Paid: _____

Do you own another Brunton / Nexus Product?

Yes. Product: _____ No.

I decided to buy this product because of ...

Recommendation Store Display Features
 Magazine Salesperson Gift
 Catalog Newspaper

This pocket transit will be used for ...

Geology Archeology Mining
 Mapping Forestry Camping
 Hunting Backpacking Orienteering

Occupation: _____

Annual Income:

< 20,000 20,000 - 39,000
 40,000 - 74,999 75,000 - 99,999 > 100,000

The Brunton Co., Limited One Year Warranty

The Brunton Company warrants this product to be free of defects in materials and workmanship. This warranty extends to the original purchaser for one year from the date of purchase.

This Warranty is void and a charge for repair will be made if:

1. The product has been damaged by negligence, accident or mishandling, or has not been operated in accordance with standard operating procedures.
2. The product was altered or repaired by other than a Brunton repair facility, or adaptations or accessories other than Brunton accessories have been attached to this Brunton product.

This warranty gives you specific legal rights, and you also have rights which vary from state to state. No other warranty, expressed or implied, applies to the Brunton product, nor is any person or company authorized to assume any other warranty for Brunton. Brunton does not assume any responsibility for any consequential damages occasioned by this product.

Should the product prove defective, call the Brunton Company, and Brunton will provide you with a **return authorization number**. Send a copy of your proof of purchase, the return authorization number, a short description of the problem and the product to Brunton at the following address. Brunton suggests insuring the product in case of damage or loss in shipment.

Transit Repair Department
The Brunton Company
620 East Monroe Avenue
Riverton, WY 82501-4997
(307) 856-6559